

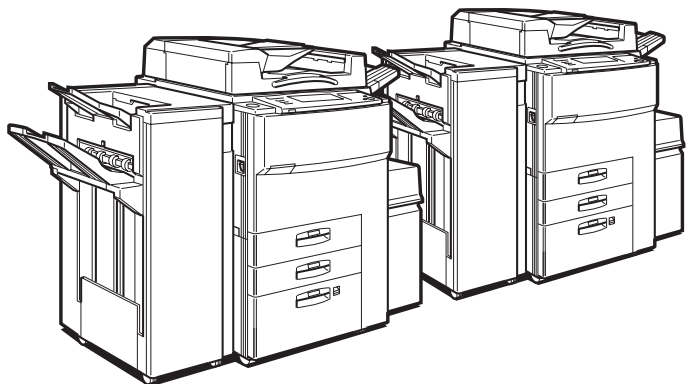

OPERATING INSTRUCTIONS

Copy Connector Kit-Type A



TRES050N

Read this manual carefully before you use this product and keep it handy for future reference.

For safety, please follow the instructions in this manual.



Introduction

This manual contains detailed instructions on the operation and maintenance of this machine. To get maximum versatility from this machine all operators should carefully read and follow the instructions in this manual. Please keep this manual in a handy place near the machine.

Please read the Safety Information before using this machine. It contains important information related to USER SAFETY and PREVENTING EQUIPMENT PROBLEMS.



Notes

Some illustrations may be slightly different from your machine.

Certain options may not be available in some countries. For details, please contact your local dealer.

Printer/Document Server features are available as options.



Notes

Two kinds of size notation are employed in this manual. With this machine refer to the Inch version.

Note to users in the United States of America

Note:

This equipment has been tested and found to comply with the limits for a Class A digital devices, pursuant to Part 15 of the FCC Rules. These limits are designed to provide reasonable protection against harmful interference when the equipment is operated in a commercial environment. This equipment generates, uses and can radiate radio frequency energy and, if not installed and used in accordance with the instruction manual, may cause harmful interference to radio communications. Operation of this equipment in a residential area is likely to cause harmful interference in which case the user will be required to correct the interference at his own expense.

Warning

Changes or modifications not expressly approved by the party responsible for compliance could void the user's authority to operate the equipment.

When this product is installed in a copy machine, it is regarded as a Class A digital device.

Note to users in Canada

Note:

This Class A digital apparatus complies with Canadian ICES-003.

Remarque concernant les utilisateurs au Canada

Avertissement:

Cet appareil numérique de la classe A est conforme à la norme NMB-003 du Canada.



Copy Connector Kit-Type A OPERATING INSTRUCTIONS



How To Read This Manual

Main Options Available

The main options are:

- Finisher
- Large Capacity Tray (LCT)

Symbols

In this manual, the following symbols are used:

 **WARNING:**

This symbol indicates a potentially hazardous situation that might result in death or serious injury when you misuse the machine without following the instructions under this symbol. Be sure to read the instructions, all of which are described in the Safety Information section.

 **CAUTION:**

This symbol indicates a potentially hazardous situation that might result in minor or moderate injury or property damage that does not involve personal injury when you misuse the machine without following the instructions under this symbol. Be sure to read the instructions, all of which are described in the Safety Information section.

* The statements above are notes for your safety.

 **Important**

If this instruction is not followed, paper might be misfed, originals might be damaged, or data might be lost. Be sure to read this.

 **Preparation**

This symbol indicates that prior knowledge or preparations required before operating.

 **Note**

This symbol indicates precautions for operation, or actions to take after misoperation.

 **Limitation**

This symbol indicates numerical limits, functions that cannot be used together, or conditions in which a particular function cannot be used.

 **Reference**

This symbol indicates a reference.

[]

Keys that appear on the machine's panel display.

【 】

Keys built into the machine's operation panel.

TABLE OF CONTENTS

1. OVERVIEW

What Is Connect Copy?	1
How Connect Copy Works	3
Connectable Copier Models	3
Functions Not Available With Connect Copy	4
Interrupt, Printer and Document Server Functions In Connect Copy Mode ..	4
Before You Start.....	4
What You Can Do With Connect Copy	6
Guide To Components	8
Operation Panel	10
Panel Display	12
Functions Supported By Connect Copy	14

2. USING CONNECT COPY

Making Copies	17
Exiting Connect Copy Mode.....	20
Differences Between Standard Copy Functions And Connect Copy Functions	21
Basic Functions.....	21
Copying From The Bypass Tray	22
Programs.....	22
Cover/Designate	22
Other Functions.....	23

3. TROUBLESHOOTING

If Your Machine Does Not Operate As You Want	25
Messages	25
Displays.....	27
If Connect Copy Is Cleared	29
If You Cannot Exit Connect Copy	31
If Copying Isn't Working As Expected	33
When Memory Is Full	33

4. USER TOOLS

Relationship Between Master Unit And Sub-Unit System Settings	35
Relationship Between Master Unit And Sub-Unit Copy Features	39

5. APPENDIX

Specifications	43
INDEX.....	44

1. OVERVIEW

What Is Connect Copy?

Connect Copy is a feature that allows you to connect two copiers together using a cable. When you set up your copy job on one unit (the master unit), data is transferred to the other unit (the sub-unit) so that copies can be made on both machines simultaneously.

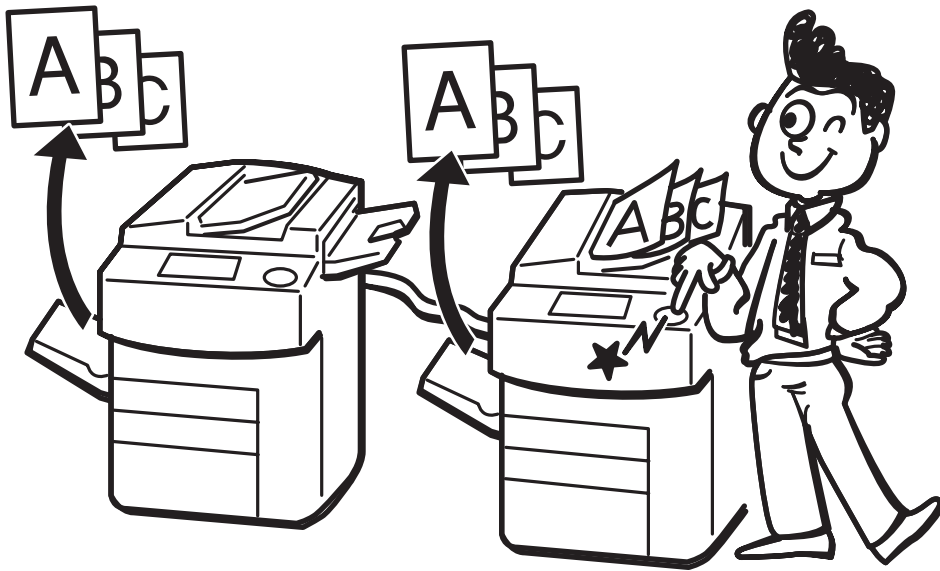

GCCONNON

Connect Copy Benefits

Connect Copy provides the following benefits:

❖ **High-speed copying for greater productivity**

For large volume copy runs, two connected machines form a single system that can complete the job in a shorter time. If two 65 copies/minute (A4 □, 8¹/₂" × 11" □ size) copiers are connected together, a 130 copies/minute (A4 □, 8¹/₂" × 11" □ size) speed will be available.

❖ **Auto-backup system for less participation of operators**

Even if one copier stops because of a paper jam, it has run out of toner, or run out of paper, the other unit will take over and finish the job automatically. If the stopped machine is recovered, the units will allocate the job again and continue using Connect Copy to complete the job in a way that results in maximum productivity.

 **Note**

- You cannot make other copy jobs when the two units are connected.
- The two machines automatically share the job in order to finish at almost the same time and get the maximum productivity.
- To use the two copiers separately again, touch the **[Connect]** key to disconnect them.

How Connect Copy Works

In this manual we refer to the two copiers as the master unit and sub-unit respectively.

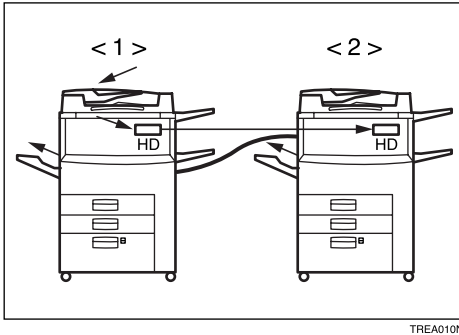

1. Master Unit

2. Sub-Unit

As your original is scanned in, the image data is stored on the master unit hard disk and transferred simultaneously to the sub-unit hard disk. As soon as scanning has finished, copying starts.

The master unit is the copier at which you touch the **[Connect]** key to enter Connect Copy mode. When you do this, the other copier becomes the sub-unit. You can use either machine as the master unit or sub-unit, but you cannot change the relationship without exiting Connect Copy mode first.

Connectable Copier Models

- The master unit and sub-unit do not have to be same speed models.

Master Unit	Sub-Unit
55 copies/minute copier	55 copies/minute copier
55 copies/minute copier	65 copies/minute copier
65 copies/minute copier	55 copies/minute copier
65 copies/minute copier	65 copies/minute copier

- You can still use Connect Copy even if no optional finisher or large capacity tray (LCT) is available. However, the optional finisher must be installed in both units in order to use the Stack and Staple functions, and the optional finisher and punch kit must be installed in both units in order to use the Punch function.

Functions Not Available With Connect Copy

The following functions are not available in Connect Copy mode:

- Next Job
- Book→1 Sided, Book→2 Sided, Multi→2 Sided, Booklet, Magazine
- Slip Sheet
- Double Copies
- Image Repeat

Interrupt, Printer and Document Server Functions In Connect Copy Mode

- Connect Copy only supports the copy feature.
- You cannot use Connect Copy when a job has been paused using the Interrupt feature.
- You can use the Interrupt feature on the sub-unit while in Connect Copy mode, but only when the master unit is not scanning originals.
- You cannot use the Printer or Document Server functions in Connect Copy mode no matter how the “Output Priority” of the User Tools (System Settings) is programmed.
- You cannot switch to the Printer or Document Server functions while in Connect Copy mode. To access these functions you must exit Connect Copy mode.

Before You Start

Both units must have paper trays loaded with paper of the same size, direction and type that you wish to copy onto.

To make the most out of the Connect Copy feature, we recommend that:

- The paper tray settings of the master unit and sub-unit match each other.
- The “Original Mode Quality Level” of the User Tools (Copy Features) settings should be the same on each unit. If they are not the same, the copied images may differ. Refer to the “Original Mode Quality Level” of the User Tools (Copy Features) in the “Copy Reference” manual.

What You Can Do With Connect Copy

1

Function names and keys that are greyed out are not available in Connect Copy mode.

For more detailed information on these functions and how to use them, please refer to the Operating Instructions "Copy Reference" manual.

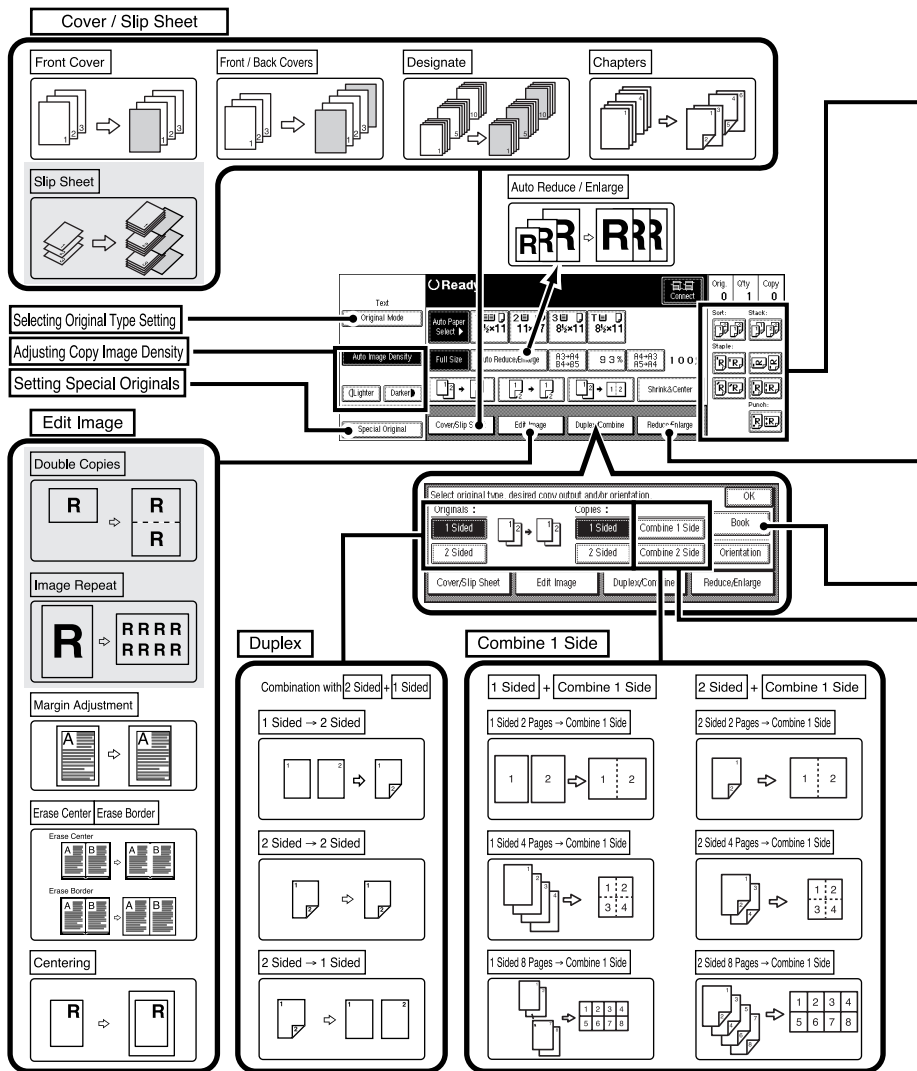

*1 Optional finisher required in both units.
 *2 Optional finisher not required.
 *3 Optional finisher and punch kit required in both units.

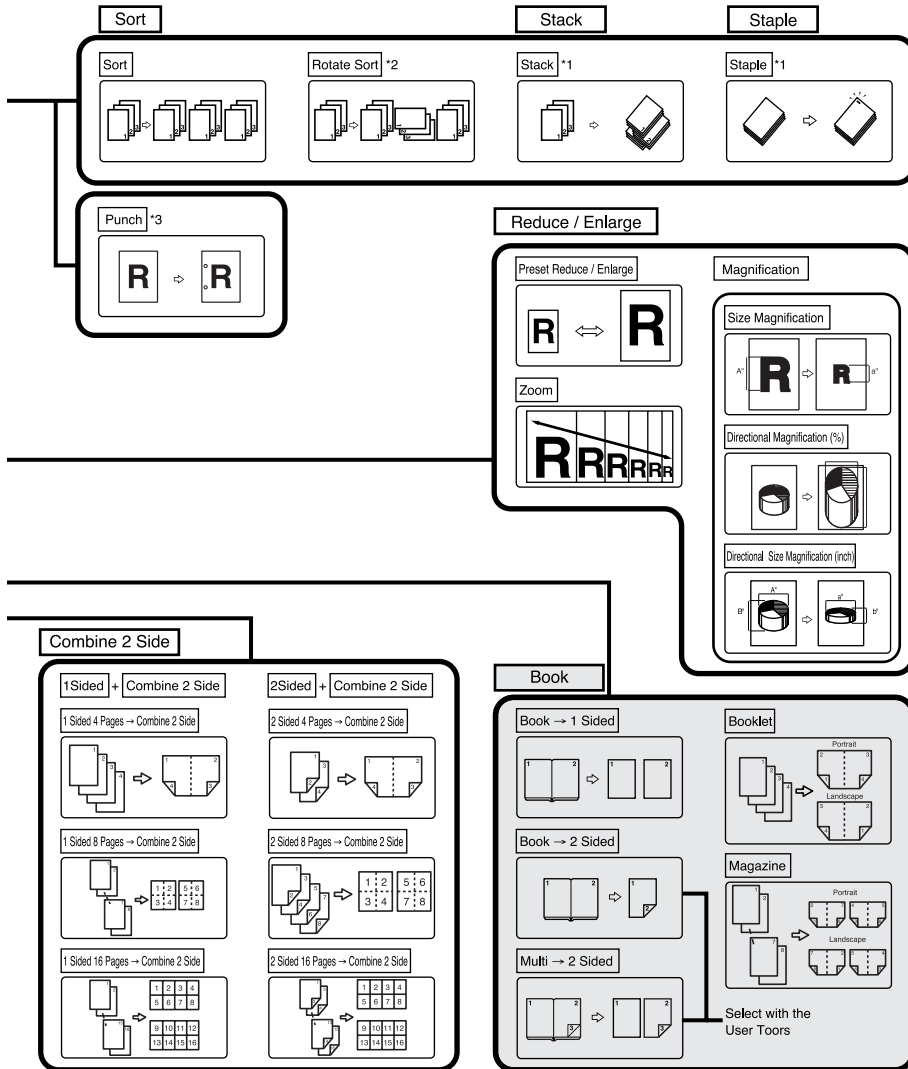

TREH010N

Guide To Components

1

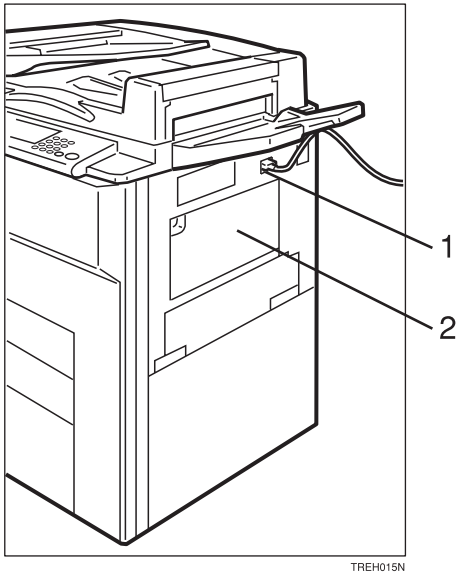

1. Connect Copy port

Attach the Connect Copy cable here.

Important

- Do not connect any other equipment to the Connect Copy port.
- Be sure to turn off the main power switch on both the master unit and sub-unit before you disconnect the Connect Copy cable. Unplugging the cable while power is on could damage the machines.

2. Bypass tray

Can be used with the Cover/Designate functions only.

Note

- Please contact your service representative before moving the copier.

Operation Panel

1

Use the master unit operation panel to access basic Connect Copy features.

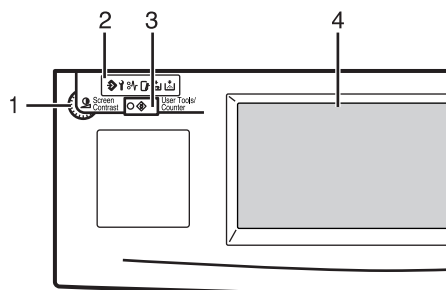

1. Screen contrast knob

Adjusts the brightness of the panel display.

2. Indicators

These indicators show errors or the status of the machine.

Refer to “WHAT TO DO IF SOMETHING GOES WRONG” in the “Copy Reference” manual.

3. [User Tools/Counter] key

- User Tools : Press to change the default settings and conditions to meet your requirements.
- Counter : Press to check or print the total number of copies made.

Refer to “USER TOOLS (Copy Features)” in the “Copy Reference” manual.

Refer to “USER TOOLS (System Settings)” in the “System Settings” manual.

4. Panel display

Shows operation status, error messages, and function menus.

See⇒ P.12 “Panel Display”

5. [Program] key

Press to select the program mode.

See⇒ P.22 “Programs”

6. [Clear Modes/Energy Saver] key

Press the [Clear Modes/Energy Saver] key on the master unit to exit Connect Copy mode and return to copy mode with default settings.

7. [Interrupt] key

Press to make interrupt copies during a copy run.

See⇒ P.23 “Interrupt”

8. [Sample Copy] key

Use this key to make a single sample copy on the master unit before starting a long copy run. By checking the finish and making any necessary changes to the image quality settings before you make multiple copies, you can save time and paper.

See⇒ P.24 “Sample Copy”

9. Main Power indicator

This indicator lights up when the main power switch is turned on, and goes off when the switch is turned off.

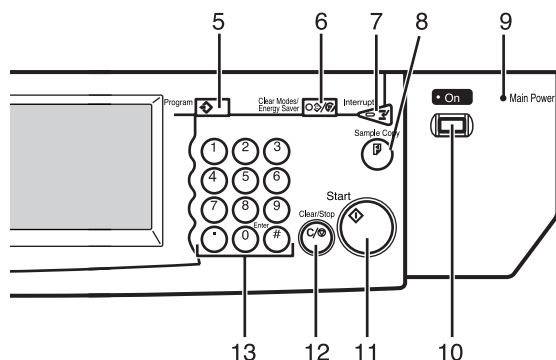

TREH300N

10. Operation switch

Press this switch to turn the power on (the **On** indicator lights up). To turn the power off, press this switch again (the **On** indicator goes off).

11. **[Start]** key

Press the **[Start]** key on the master unit to start reading in your original. When scanning is complete, the master and sub-unit start copying simultaneously.

12. **[Clear/Stop]** key

- When entering numbers : Cancels a number you have entered.
- When copying : Press on the master unit to stop both units copying.

13. **[Number]** keys

Use to enter the desired number of copies and data for selected modes.

Use the Enter key to enter data in selected modes.



Panel Display

This section describes the displays on the master unit and sub-unit.

Note that when you enter Connect Copy mode, you must access all Connect Copy features and menus through the master unit display panel.

1

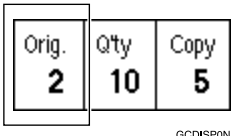
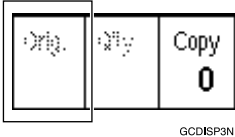
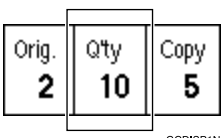
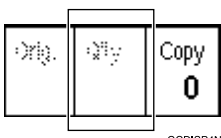
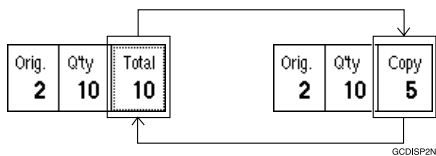
	Master Unit	Sub-Unit
Initial display in standard copy mode		
Initial display in Connect Copy mode		
Display when scanning originals on the master unit		
Display when copying/Interrupt copying		

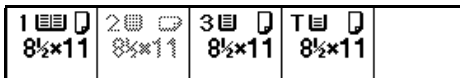
	Master Unit	Sub-Unit
Number of originals	<p>How many original pages have been scanned by the master unit so far.</p>  <p style="text-align: center;">GCDISP0N</p>	<p>Not displayed on sub-unit.</p>  <p style="text-align: center;">GCDISP3N</p>
Copy quantity	<p>How many sets/copies to make.</p>  <p style="text-align: center;">GCDISP1N</p>	<p>Not displayed on sub-unit.</p>  <p style="text-align: center;">GCDISP4N</p>
Copy counter	<p>Displays how many sets/copies made by the master unit so far. *1</p>  <p style="text-align: center;">GCDISP2N</p>	<p>Displays how many sets/copies made by the sub-unit so far.</p>  <p style="text-align: center;">GCDISP5N</p>
Copy Paper Select	<p>Only paper trays loaded with the paper of the same size, direction and type installed in both the master unit and sub-unit are displayed.</p> <p>Other paper tray types will be greyed out and you cannot select them. *2</p> 	<p>Only paper trays loaded with the paper of the same size, direction and type installed in both the master unit and sub-unit are available.</p> <p>Note that you can only select the copy paper from the master unit operation panel.</p> 

*1 When two or more pages are being copied using Sort and Staple, you can check how many sets have been copied so far. To toggle the copy counter between the master unit total and the total for both units, touch the area that displays the number of copies. "Copy" means the number of sets made so far by the master unit and "Total" means the total number of sets made so far by both units.

*2 The bypass tray can use only for Cover/Designate functions.

Functions Supported By Connect Copy

There are some differences in the functions supported by Connect Copy and standard copying. Functions marked with an [×] in the table below cannot be used with Connect Copy.

☆...Available

×...Not available

Mode	Available or not	
Batch (SADF) mode	☆	
Mixed Sizes mode	☆	
Thin mode	☆	
Adjusting Copy Image Density	☆	
Selecting Original Type Setting	☆	
Selecting Copy Paper	☆	
Auto Reduce/Enlarge	☆	
Sort	☆	
Rotate Sort	☆ *1	
Stack	☆ *2	
Punch	☆ *3	
Staple	☆ *2	
Copying From The Bypass Tray	☆ *4	
Program	☆ *5	
Preset Reduce/Enlarge	☆	
Zoom	☆	
Size Magnification	☆	
Directional Magnification (%)	☆	
Directional Size Magnification (inch)	☆	
Duplex	1 Sided→2 Sided	☆
	2 Sided→2 Sided	☆

Mode	Available or not
Combine	1 Sided 2 Pages→Combine 1 Side ☆
	1 Sided 4 Pages→Combine 1 Side ☆
	1 Sided 8 Pages→Combine 1 Side ☆
	1 Sided 4 Pages→Combine 2 Side ☆
	1 Sided 8 Pages→Combine 2 Side ☆
	1 Sided 16 Pages→Combine 2 Side ☆
	2 Sided 2 Pages→Combine 1 Side ☆
	2 Sided 4 Pages→Combine 1 Side ☆
	2 Sided 8 Pages→Combine 1 Side ☆
	2 Sided 4 Pages→Combine 2 Side ☆
	2 Sided 8 Pages→Combine 2 Side ☆
	2 Sided 16 Pages→Combine 2 Side ☆
Book	Book→1 Sided ×
	2 Sided→1 Sided ☆
	Book→2 Sided ×
	Multi→2 Sided ×
	Booklet ×
	Magazine ×
Cover/Designate/Chapters	☆
Slip Sheet	×
Double Copies	×
Image Repeat	×
Margin Adjustment	☆
Erase Center/Border	☆

Mode	Available or not
Centering	☆
Interrupt	☆ *6
Next Job	×
Sample Copy	☆ *7

*1 Only when the optional finisher is not installed in both units.

*2 Optional finisher required in both units.

*3 Optional finisher and punch kit required in both units.

*4 Only with Cover/Designate.

*5 When you recall a program it is retrieved from the master unit. If your program contains settings that are not available in Connect Copy mode or the sub-unit does not support certain features stored in the program, they are ignored.

*6 Available only on the sub-unit, and only when the master unit is not scanning originals.

*7 Master unit only.

2. USING CONNECT COPY

Making Copies

You can select Connect Copy mode from either of the two connected copiers by touching the **[Connect]** key. The copier you use becomes the master unit, and the other copier the sub-unit.

! Limitation

- Once Connect Copy is selected, you must carry out all operations from the master unit.

1 Make sure the machine is in copy mode.

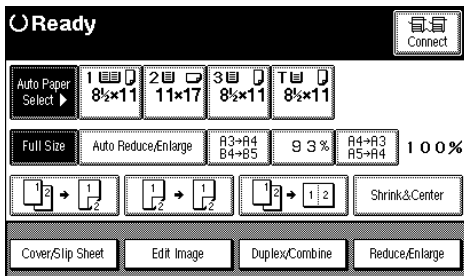

📝 Note

- If User Codes are turned on, enter a User Code programmed in the master unit with the number keys (maximum 8 digits) then press the **[#]** key. You don't need to enter the user code for the sub-unit.

🔍 Reference

See ⇒ P.24 "User Codes"

2 Touch the **[Connect]** key on the unit that is to be the master unit.

When the key darkens, the two units are connected.

❖ Master Unit display

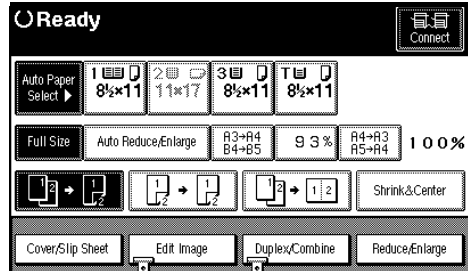

❖ Sub-Unit display

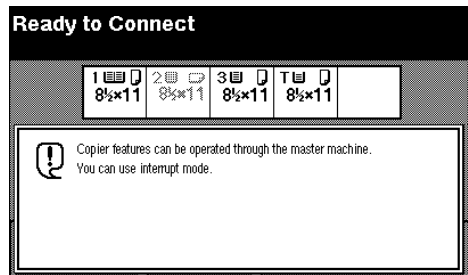

🔍 Reference

If the **[Connect]** key is not visible or you cannot select it, see ⇒ P.27 "Displays".

If you touch the **[Connect]** key and the message "Connect Copy is not available at this time. Please check the connected machine. Press **[Cancel]**, connect copy will be cancelled" appears, see ⇒ P.25 "Messages".

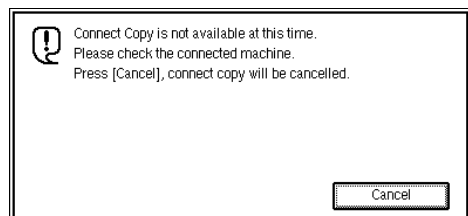

3 Set your originals in the master unit.

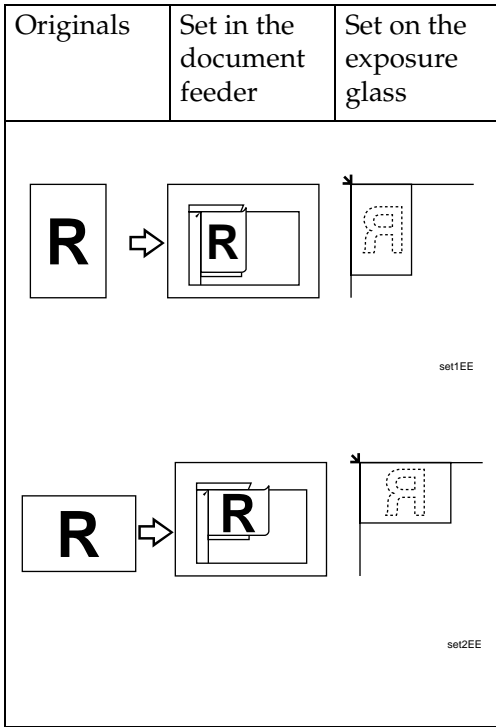

Reference

Refer to “Setting Originals” in the “Copy Reference” manual.

4 Make any settings you require on the master unit.

Note

- Any copy settings that were set up before you entered Connect Copy mode will still remain in effect. However, if optional finishers are not installed on both the master unit and sub-unit, the Stack, Staple and Punch features will be automatically disabled.
- For more information on functions you can use with Connect Copy, see ⇒ P.14 “Functions Supported By Connect Copy”.

- To exit Connect Copy mode, touch the **[Connect]** key on the master unit again.

5 Enter the number of copies you require with the **[Number]** keys.

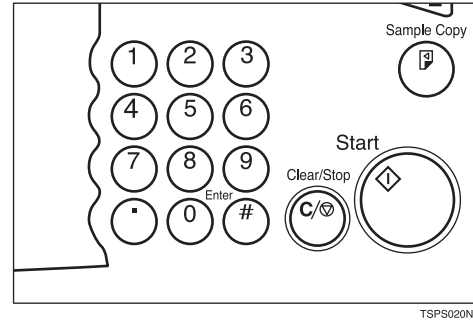

Note

- You can enter up to 999 copies.
- If you make a mistake, press the **[Clear/Stop]** key and enter a new number.
- Even though Connect Copy is selected, only the master unit will make copies in the following situations:
 - When making a single copy set
 - When the original is a single sheet and you enter a low number of copies/sets

6 Press the **[Start]** key on the master unit.

Copying starts after the original has been scanned.

Note

- If you have set your originals in the document feeder (ADF), copying starts simultaneously in the master unit and sub-unit after all originals have been scanned.
- Using the Batch (SADF) mode, you need to set your originals,

then press the **[Start]** key. After all the previously set originals while the Auto Feed indicator is lit. When all pages have been scanned in, press the **[#]** key. Copying starts simultaneously in the master and sub-unit. Refer to “Batch (SADF) mode” in the “Copy Reference” manual.

- ❑ When scanning from the exposure glass, you need to set the next page(s) when scanning has finished, then press **[Start]** key. When all pages have been scanned in, press the **[#]** key. Copying starts simultaneously in the master unit and sub-unit.
- ❑ To stop originals being scanned or copied, press the **[Clear/Stop]** key on the master unit and follow the instructions on the display.

Reference

See ⇒ P.33 “When Memory Is Full”.

7 Pick up your copies from the master unit and sub-unit.

Note

- ❑ The number of sheets and sets copied by the master unit and sub-unit may be different.
- ❑ The master unit and sub-unit may not finish copying at the same time.
- ❑ When using the Sort/Staple feature, copies are organized into copy sets. If there is a paper jam in one machine during this process, it is not possible for the other machine to take over the copy set processing of the down machine.

Copy Output Order

When copying in Sort/Staple mode

E.g. copying 6-sets of a 3-sheet original

- Copying with the master unit (face-down output) — sub-unit (face-down output)

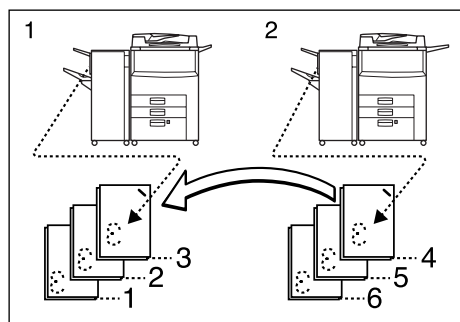

1. Master Unit

2. Sub-Unit

When using Sort/Staple, your copies sets are not split between the master unit and sub-unit.

When copying without Sort/Staple mode

E.g. making 2 copies of each page of a 6-sheet original

- Copy with the master unit (face-down output) — sub-unit (face-up output)

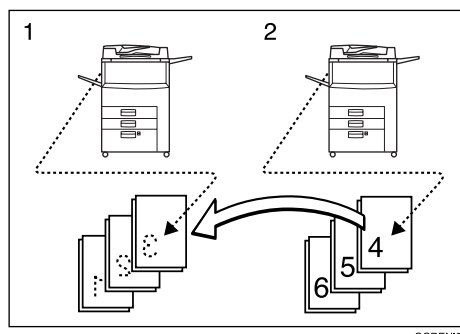

1. Master Unit

2. Sub-Unit

Combine your copy stacks from the master unit and sub-unit as shown in the diagram.

Auto Reset

The machine exits Connect Copy mode and automatically returns to the initial condition a certain period of time after your job has finished.

Note

- When the master unit “Auto Reset Timer” of the User Tools (Copy Features) delay elapses, the master unit will be reset automatically.
- When the sub-unit “System Reset” of the User Tools (System Settings) delay elapses, Interrupt mode will be cancelled on the sub-unit.

Reference

Refer to the “Auto Reset Timer” of the User Tools (Copy Features) in the “Copy Reference” manual.

Auto Off

The machine turns itself off automatically a certain period of time after your job has finished. This function is called “Auto Off”.

Note

- You can change the Auto Off time.

Reference

Refer to the “Auto Off Timer” of the User Tools (System Settings) in the “System Settings” manual.

Exiting Connect Copy Mode

This procedure describes how to exit Connect Copy mode and return to the standard copying functions.

- 1** Touch the **[Connect]** key on the master unit.

The **[Connect]** key will be deselected.

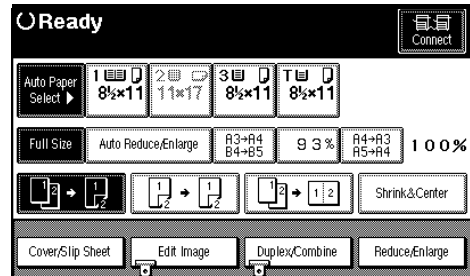

Note

- Settings that were selected on the master unit while in Connect Copy mode will not be cleared.
- If you press the **[Clear Modes/Energy Saver]** key on the master unit, the master unit settings will revert to those that were selected before entering Connect Copy mode.
- The sub-unit will return to the state it was in prior to entering Connect Copy mode.

Reference

If you cannot exit Connect Copy mode by touching the **[Connect]** key, see ⇒ P.31 “If You Cannot Exit Connect Copy”.

Differences Between Standard Copy Functions And Connect Copy Functions

This section explains the differences between standard copy functions and those used with Connect Copy.

Basic Functions

Adjusting Copy Image Density

Make adjustments to copy image density on the master unit.

Note

- You can adjust copy image density on the master unit while scanning originals, but the change will be reflected from the next copying.
- The image density level set on the master unit will be used by both units. However, in order to produce similar images on both units, make sure the “Original Mode Quality Level” settings are the same on each unit. If they are not the same, the finish of images may differ.

Reference

Refer to “Original Mode Quality Level” of the User Tools (Copy Features) in the “Copy Reference” manual.

Refer to “Adjusting Copy Image Density” of the User Tools (Copy Features) in the “Copy Reference” manual.

Selecting Original Type Setting

Select an original type that matches your original on the master unit.

Reference

Refer to “Selecting Original Type Setting” in the “Copy Reference” manual.

Selecting Copy Paper

Use the master unit to select the paper you wish to copy onto.

Preparation

We recommend that the master unit and sub-unit have the same paper tray settings. This is because only paper trays with the same size, direction, and type of paper can be used in Connect Copy mode.

If several trays with the same paper settings are available in the sub-unit, paper will be supplied from the tray specified by the “Paper Tray Priority” of the User Tools (Copy Features).

Note

- After you touch the **[Connect]** key to enter Connect Copy mode, only paper trays common to the master unit and sub-unit will be selectable. Other paper tray keys will be greyed out and you cannot select them.
- If you turn “Auto Tray Switching” of the User Tools (System Settings) to “Yes”, paper tray with the same size and type of paper will be selected and make copies with the image rotated.

There are two ways of selecting copy paper:

❖ Automatic Paper Select

The machine selects a suitable size of copy paper automatically based on the original size and the reproduction ratio.

❖ Manual Paper Select

You must choose the tray with the paper you wish to copy onto: Paper Tray or Large Capacity Tray (LCT).

🔍 Reference

Refer to “Selecting Copy Paper” the “Copy Reference” manual.

Copying From The Bypass Tray

Can be used with the Cover/Designate functions only.

🔍 Reference

See ⇒ P.22 “Cover/Designate”.

Programs

If you use certain combinations of settings on a frequent basis, store them in a program on the master unit so that you can recall them quickly and easily.

❖ Storing Your Settings

Store your settings in a program in the master unit.

❖ Deleting A Program

You can delete a stored program.

❖ Recalling A Program

You can recall a stored program from the master unit.

📝 Note

- ❑ If your program contains settings that are not available in Connect

Copy mode, they will be ignored. See ⇒ P.14 “Functions Supported By Connect Copy”.

- ❑ If your program contains settings that are not available on the sub-unit, they are ignored. If the finisher is not installed in the sub-unit, the staple function is ignored.
- ❑ You cannot store the setting whether the Connect Copying function will be selected automatically in a program.

🔍 Reference

Refer to “Program” in the “Copy Reference” manual.

Cover/Designate

You can make copies of front and back covers onto special paper, and copy designated pages onto slip sheets.

⚠️ Limitation

- ❑ The bypass tray can only be used for cover and slip sheet copy paper.
- ❑ Before selecting functions on both the master unit and sub-unit, you must set the “Bypass Tray: Special Paper Indication” of the User Tools (System Settings) setting for Cover Sheet/Slip Sheet with the User Tools.
- ❑ Load paper of the same size and direction when copying covers and slip sheets.

When using the cover sheet or the slip sheet set on the bypass tray

❖ Copying Onto Spacial Paper

Program the paper type before touching the **[Connect]** key.

Note

- You cannot set non-standard size paper in the Bypass Tray.

Reference

Refer to “When copying onto OHP transparencies or thick paper” in the “Copy Reference” manual.

Refer to “Copying From The Bypass Tray” in the “Copy Reference” manual.

Other Functions

Energy Saver Mode

When you hold down the **[Clear Modes/Energy Saver]** key for more than about one second on the master unit, the display goes out and the machine enters Energy Saver mode. If you press the **[Clear Modes/Energy Saver]** key again, set originals in the document feeder, or raise the document feeder, the machine returns to the standby condition. In Energy Saver mode, the machine uses less electricity.

Note

- If you press the **[Clear Modes/Energy Saver]** key during an operation, the current settings will be cleared.
- If you touch the **[Connect]** key on the master unit, the sub-unit exits

Energy Saver mode and enters Connect Copy mode.

- Pressing the **[Clear Modes/Energy Saver]** key on the sub-unit has no effect in Connect Copy mode.
- In Connect Copy mode, the sub-unit will not enter Energy Saver mode.

Reference

Refer to “Energy Saver Mode” in the “Copy Reference” manual.

Interrupt

Use this feature if you wish to interrupt a long copy job to make urgently needed copies.

Note

- You can only use Interrupt on the sub-unit.
- You can not use Interrupt on the sub-unit while the master unit is scanning an original.
- Interrupt mode is not used when memory is full.
- When you have finished Interrupt copying, please exit this mode. The Connect Copy job will be re-assigned to the Connect Copy job again.
- Please exit the Interrupt mode after finishing the job. The next copy job cannot be set up if the sub-unit is in Interrupt mode.

Reference

Refer to “Interrupt” in the “Copy Reference” manual.

User Codes

If the User Codes function is turned on in the master unit, operators must input their user code before they can use the machine. The machine also keeps count of the number of copies made under each code.

 **Note**

- You can turn User Codes on or off with the master unit System Settings. Refer to “Set User Codes” of the User Tools (System Settings) in the “System Settings” manual.
- You can monitor the total number of copies made by the master unit and sub-unit with the master unit User Codes function.
- If User Codes are set on in the sub-unit and a code has been entered before Connect Copy was selected, the master unit cannot monitor the number of copies made.
- If User Codes are turned on only in the sub-unit, you can enter Connect Copy mode and make copies without entering a code. In this case the number of copies made will not be monitored.

 **Reference**

Refer to “User Codes” in the “Copy Reference” manual.

Auto Start

If you press the **[Start]** key during the warm-up period, the **[Start]** key will blink, and copying will start as soon as the warm-up finishes.

 **Note**

- Copying will start if “Ready” is displayed on the master unit.

- To cancel Auto Start, press the **[Clear/Stop]** key.

 **Reference**

Refer to “Auto Start” in the “Copy Reference” manual.

Sample Copy

This feature lets you make a single sample copy set so you can make any adjustments to the copy settings before starting a large copy job. It is only available on the master unit.

 **Reference**





Refer to “Sample Copy” in the “Copy Reference” manual.



3. TROUBLESHOOTING

If Your Machine Does Not Operate As You Want



Messages





This section describes the most common error messages that may appear on the display and various countermeasures you can take to solve the problem. If a message not listed here appears, please refer to the “Message” section of the “Copy Reference” manual.

Message	Problem/Cause	Action
Connect Copy is not available at this time. Please check the connected machine. Press [Cancel] , connect copy will be cancelled. [Cancel]	The sub-unit has a paper jam or needs a fresh supply of toner or other replenishable supply.	Touch the [Cancel] key on the master unit and follow the instructions given on the sub-unit display.  Reference Refer to “  Adding Toner” in the “Copy Reference” manual. Refer to “   Clearing Misfeeds” in the “Copy Reference” manual. Refer to “  Removing Jammed Staples” in the “Copy Reference” manual. If the sub-unit display shows that a cover is open, follow the instructions given. For all other situations, follow the instructions on the display.
	The User Tools menu is open on the sub-unit.	Touch the [Cancel] key on the master unit. Then on the sub-unit press the [User Tools/Counter] key to close the User Tools menu.

Message	Problem/Cause	Action
Connect Copy is not available at this time. Please check the connected machine. Press [Cancel] , connect copy will be cancelled. [Cancel]	The sub-unit is busy copying or printing with another function.	Touch the [Cancel] key on the master unit then stop the sub-unit from copying/printing.
	The sub-unit is in Interrupt mode.	Touch the [Cancel] key on the master unit. Then press the [Interrupt] key on the sub-unit to exit Interrupt mode.  Reference See ⇒ P.23 “Interrupt”.
	The sub-unit has been switched off automatically by the Weekly Timer feature and is waiting for the Key Operator Off Code to be entered.	Touch the [Cancel] key on the master unit. Then on the sub-unit enter the code and press the [#] key.  Reference Refer to “Key Operator Code for Off Setting” of the User Tools (System Settings) in the “System Settings” manual.
	The sub-unit is not in copy mode (i.e. in Printer or Document Server mode).	Touch the [Cancel] key on the master unit. Then press the [Copy] key on the sub-unit to switch over to copy mode.
	[Connect] was pressed simultaneously on both the master unit and sub-unit.	Touch the [Cancel] key on both the master unit and sub-unit, then touch the [Connect] key on just one of them.
	 indicator is lit on the sub-unit.	Follow the instructions shown on the display.
Can not connect. The other machine is use.	The master unit is not in copy mode (i.e. in Printer or Document Server mode).	Touch the [Cancel] key on the master unit. Then press the [Copy] key on the master unit to switch over to the copy function.

Displays

Machine Status	Problem/Cause	Action
The [Connect] indicator does not appear on the display.	The main power switch on the sub-unit is off.	Turn on the sub-unit main power switch.
	The operation switch on the sub-unit is off.	Press the operation switch on the right side of the operation panel. The On indicator will light.  Note <input type="checkbox"/> The machine will be ready to operate about five minutes after turning power on.  Reference See "Operation Switch" in ⇒ P.10 "Operation Panel"
	The master unit is not in copy mode (i.e. in Printer or Document Server mode).	Press the [Copy] key on the master unit to switch to the copy function.
	The master unit is in Interrupt mode.	Press the [Interrupt] key on the master unit to exit Interrupt mode.  Reference See ⇒ P.23 "Interrupt".



Machine Status	Problem/Cause	Action
<p>The [Connect] indicator does not appear on the display.</p>	<p>The master unit is in Next Job mode.</p>	<p>Exit Next Job mode in one of the following ways.</p> <ul style="list-style-type: none"> ❖ If you are still selecting copy settings and copying has not started yet: Touch the [Clear] key then remove the originals set in the master unit auto document feeder (ADF) . ❖ If Next Job mode is in progress: Press the [Clear/Stop] key, follow the instructions on the display then touch the [Cancel] key. <p> Reference Refer to "Next Job" in the "Copy Reference" manual.</p>
	<p>The "Connect Copy" of the User Tools setting (Copy Features) is set to "No".</p>	<p>Change the setting to "Yes" or touch the [Connect] key on the other unit.</p> <p> Reference See "Connect Copy" in ⇒ P.42 "User Tools (Copy Features) For Connect Copy"</p>
	<p>The Connect Copy cable is damaged.</p>	<p>Please contact your service representative.</p>
	<p> indicator is lit.</p>	<p>Follow the instructions shown on the display.</p>
<p>The [Connect] key is greyed out.</p>	<p>The master unit is now copying or copying will start as soon as the warm-up finishers.</p>	<p>Press the master unit [Clear/Stop] key to cancel copying.</p> <p> Reference See "[Clear/Stop] key" in ⇒ P.10 "Operation Panel"</p>

Machine Status	Problem/Cause	Action
The [Connect] key is greyed out.	Copying has stopped because there is a paper jam or toner has run out on the unit you wish to use as the master unit.	Solve the problem on the master unit.
	Functions are programmed that cannot be used with Connect Copy.	Press the master unit [Clear Modes/Energy Saver] key to clear the programmed functions.  Reference See ⇒ P.14 “ <i>Functions Supported By Connect Copy</i> ”.





If Connect Copy Is Cleared







We will now explain the procedures to be used when Connect Copy is cleared.

Machine Status	Cause	Action
Exited Connect Copy.	The master unit main power switch has been turned off or the operation switch has been pressed.	Connect Copy is cancelled and the display returns to copy standby mode. On the master unit, either turn on the main power switch or press the operation switch, then touch the [Connect] key and start your copy job again.  Reference See “Operation Switch” in ⇒ P.10 “ <i>Operation Panel</i> ”

Machine Status	Cause	Action
Exited Connect Copy.	Either the sub-unit main power switch has been turned off or the operation switch has been pressed.	<p>A message requesting you to check the sub-unit is displayed on the master unit. Touch the [Cancel] key and clear connect-copying. Either turn on the main power switch on the sub-unit or press the operation switch and then touch the [Connect] key.</p> <p> Reference See "Operation Switch" in ⇒ P.10 "Operation Panel"</p>
	The Weekly Timer function has automatically turned the master unit off.	<p>Press the master unit operation switch then touch the [Connect] key and copy.</p> <p> Reference Refer to the "Weekly Timer" of the User Tools (System Settings) in the "System Settings" manual. See "Operation Switch" in ⇒ P.10 "Operation Panel"</p>
An error message indicating a breakdown is shown on the master unit display.	! indicator is lit.	Follow the instructions displayed in the error message. Copying is not possible.

If You Cannot Exit Connect Copy

Status	Cause	Action
Nothing happens when you press the [Connect] key.	Originals are being scanned or copied.	<p>Press the master unit [Clear/Stop] key to cancel scanning or copying.</p> <p> Reference See "[Clear/Stop] key" in ⇒ P.10 "Operation Panel"</p>
	There is a paper jam in either the master unit or sub-unit.	<p>Clear the paper jam in the master unit or sub-unit.</p> <p> Reference Refer to " Clearing Misfeeds" in the "Copy Reference" manual. Refer to " Removing Jammed Staples" in the "Copy Reference" manual.</p> <p>If the "Cover Open" display appears, follow the instructions given.</p> <p>For any other problems, follow the instructions that are displayed.</p> <p>To exit Connect Copy mode, press the master unit [Clear/Stop] key, then touch the [Connect] key.</p>
	The master unit [Clear/Stop] key was pressed and scanning of the original has been interrupted.	To exit Connect Copy mode, follow the instructions on the display, then touch the [Cancel] key.
	The [Clear/Stop] key was pressed on either the master unit or sub-unit and copying has been interrupted.	To exit Connect Copy mode, follow the instructions on the display, then touch the [Cancel] key.

Status	Cause	Action
<p>Nothing happens when you press the [Connect] key.</p>	<p>The master unit or sub-unit needs a fresh supply of toner or staples.</p>	<p>Solve the problem in the appropriate unit.</p> <p> Reference</p> <p>Refer to “ Loading Paper” in the “Copy Reference” manual.</p> <p>Refer to “ Adding Toner” in the “Copy Reference” manual.</p> <p>Refer to “ Adding Staples” in the “Copy Reference” manual.</p> <p>Refer to “ Removing Punch Waste” in the “Copy Reference” manual.</p> <p>For any other problems, follow the instructions that are displayed.</p> <p>To exit Connect Copy mode, press the master unit [Clear/Stop] key, then touch the [Cancel] key.</p> <p>See “[Clear/Stop] key” in ⇒ P.10 “Operation Panel”</p>
	<p>A paper jam occurred during stapling.</p>	<p>Remove the jammed paper.</p> <p>To exit Connect Copy mode, press the [Clear/Stop] key, then touch the [Connect] key.</p> <p> Reference</p> <p>See “[Clear/Stop] key” in ⇒ P.10 “Operation Panel”</p>

If Copying Isn't Working As Expected

This section describes how to troubleshoot problems associated with copying. If you cannot find a solution here, please refer to “If Your Machine Does Not Operate As You Want” in the “Copy Reference” manual.

Phenomenon	Cause	Action
Cannot stack, staple or punch.	The finisher is not installed in the sub-unit.	Touch the [Connect] key (the key darkens) to exit Connect Copy mode, then copy using stack/staple/punch.
The copied images differ.	The “Original Mode Quality Level” of the User Tools (Copy Features) settings are not the same.	Refer to the “Original Mode Quality Level” of the User Tools (Copy Features) settings in the “Copy Reference” manual.

3

When Memory Is Full

Because Connect Copy scans in all your originals into memory, if the number of originals exceeds a certain limit, the machine will run out of memory.

Limitation

- If memory is full on either the master unit or sub-unit, Interrupt Copy will not be available.

Note

- If you set the “Memory Full Auto Scan Restart” of the User Tools (Copy Features) to “Yes”, the memory overflow message will not be displayed, but make Connect Copy for the scanned original automatically. Connect Copy continues scanning and copying until finishing the job. Please note that copy sets will be printed out separated by scanning at this time.

Message	Phenomenon	Action
Memory is full. ## originals have been scanned. Do not remove the remaining originals. Press [Output] to copy scanned originals. [Clear] [Output]	Scanning memory is full.	Touch [Output] to copy scanned originals and clear the scanning data. Touch [Clear] to clear the scanning data and not copy.
Press [Resume] to scan the remaining originals. [Cancel] [Resume]	Confirmation whether to continue copying the rest of the originals.	To continue copying, remove all copies then touch the [Resume] key. To stop copying, touch the [Cancel] key.

4. USER TOOLS

Relationship Between Master Unit And Sub-Unit System Settings

This section describes which System Settings are used by the master unit and sub-unit in Connect Copy mode.

Note

- In Connect Copy mode the **[User Tools/Counter]** key on the sub-unit is disabled. To access the User Tools on the sub-unit, you need to exit Connect Copy mode first.

Reference

Refer to the “System Settings” manual for details.

Symbol	Meaning
☆	Master unit uses the master unit setting or sub-unit uses the sub-unit setting
←	Both units use the master unit setting
—	Unrelated
★	Depends on the function

Menu	Master Unit	Sub-Unit	Remarks
Basic Page 1			
Operation Panel Beeper	☆	☆	
Ready Operation Panel Beeper	☆	☆	
Copy Count Display	—	—	The copy counter is always displayed in count up mode.
Auto Response (Human) Sensor	☆	Invalid	Disabled even if the sub-unit setting is “Yes”.
Auto Tray Switching	☆	☆	
Auto Off Timer	☆	—	

Menu	Master Unit	Sub-Unit	Remarks
Low Power Shift Time	—	—	In Connect Copy mode, neither unit will enter any of the Energy Saver modes (Low Power mode, Energy Saver mode). When Connect Copy is exited, the machines will enter Energy Saver mode after the programmed delay elapses.
Low Power Timer	—	—	
ADF Orig. Ejection	☆	—	
<F/F4> Size Setting	☆	☆	
Basic Page 2			
Function Priority	—	—	When the master unit the “Auto Reset Timer” of the User Tools (Copy Features) delay elapses then the “System Reset” of the User Tools (System Settings) delay elapses, only the master unit returns to the function defined by the “Function Priority” of the User Tools (System Settings) setting.
System Reset	—	★	Interrupt mode on the sub-unit will be cleared by this timer.
Output Priority	—	—	Connect Copy has priority over all other functions (Printer, Document Server). When Connect Copy is exited, other functions are resumed.
Function Reset Timer	—	—	
Copy: Output Tray	☆	☆	
Document Server: Output Tray	—	—	
Printer: Output Tray	—	—	
Interleave Print	—	—	Connect Copy has priority over all other functions (Printer, Document Server). When Connect Copy is exited, other functions are resumed.

Menu	Master Unit	Sub-Unit	Remarks
Set Time			
Set Date	☆	☆	
Set Time	☆	☆	
Weekly Timer: Monday to Sunday	☆	—	The function is disabled on the sub-unit in Connect Copy mode. When Connect Copy is exited, the power will be switched off at the time specified by the timer.
Key Operator Code for Off Setting	—	—	
Paper Size Setting			
Tray 1: Paper Size Setting	☆	☆	We recommend that the master unit and sub-unit have the same paper tray settings. This is because only paper trays with the same size, direction, and type of paper can be used in Connect Copy mode.
Tray 2: Paper Size Setting	☆	☆	
Tray 3: Paper Size Setting	☆	☆	
Bypass Tray: Special Paper Indication	★	★	Can be used only with the Cover/Designate functions.
Tray 1: Special Paper Indication	☆	☆	We recommend that the master unit and sub-unit have the same paper tray settings. This is because only paper trays with the same size, direction, and type of paper can be used in Connect Copy mode.
Tray 2: Special Paper Indication	☆	☆	
Tray 3: Special Paper Indication	☆	☆	
LCT: Special Paper Indication	☆	☆	
Count Manager			
Set User Codes	☆	—	Access these settings on the master unit. The master unit settings override those of the sub-unit.
Key Operator Code	—	—	

Menu	Master Unit	Sub-Unit	Remarks
Memory Allocation	☆	☆	Memory Allocation for the copy function set in each unit will be used for Connect Copy mode.
AOF (Keep It On.)	—	—	Neither the master unit nor sub-unit will be turned off by this feature in Connect Copy mode. The power will go off after you have exited Connect Copy mode and the AOF Delay has elapsed.

Relationship Between Master Unit And Sub-Unit Copy Features

This section describes which Copy Feature settings are used by the master unit and sub-unit in Connect Copy mode.

Note

- ❑ In Connect Copy mode the **[User Tools/Counter]** key on the sub-unit is disabled. To access the User Tools on the sub-unit, you need to exit Connect Copy mode first.

Reference

Refer to “USER TOOLS (COPY FEATURES)” in the “Copy Reference” manual.

Symbol	Meaning
☆	Master unit uses the master unit setting or sub-unit uses the sub-unit setting
←	Both units use the master unit setting
—	Unrelated

Menu	Master Unit	Sub-Unit	Remarks
General features			
Auto Paper Select Priority	☆	—	Trays with the same size and direction of paper will be selected from the master unit and sub-unit automatically.
Auto Paper Select Tray Display	☆	—	The sub-unit displays the type of paper whether this function is selected or not.
Auto Image Density Priority	☆	—	
Original Mode Priority	☆	—	
Original Mode Display	☆	—	
Original Mode Quality Level	☆	☆	Same level should be selected on both units.
Original Image Density Level	☆	☆	Each unit uses its own programmed value.

Menu	Master Unit	Sub-Unit	Remarks
Auto Reset Timer	☆	—	Connect Copy will be cancelled according to the timer on the master unit.
Paper Tray Priority	☆	☆	
Shortcut R/E	☆	—	
R/E Priority	☆	—	
Duplex Mode Priority	☆	—	
Copy Orientation in Duplex Mode	☆	—	
Original Orientation in Duplex Mode	☆	—	
Book Duplex	☆	—	
Initial Mode	☆	—	
Maximum Copy Quantity	☆	—	
Original Beeper	☆	—	
Shrink & Center Ratio	☆	—	
Shortcut Keys: F1	☆	—	
Shortcut Keys: F2	☆	—	
Shortcut Keys: F3	☆	—	
Shortcut Keys: F4	☆	—	
Job End Call	☆	☆	When turned on, the beeper sounds only on the master unit when copying is completed. Only if the "Ready Operation Panel Beeper" of the User Tools (System Settings) is on.
Reproduction Ratio			
Enlarge 1-5	☆	—	
Priority Setting: Enlarge	☆	—	
Reduce 1-6	☆	—	
Priority Setting: Reduce	☆	—	

Menu	Master Unit	Sub-Unit	Remarks
Page Format			
Cover Mode	☆	—	The master unit setting will be applied.
Copy Back Cover	☆	—	
Front Margin: Left/Right	☆	←	
Back Margin: Left/Right	☆	←	
Front Margin: Top/Bottom	☆	←	
Back Margin: Top/Bottom	☆	←	
1→2 Duplex Auto Margin Adjust	☆	←	
Erase Border	☆	←	
Combine Original Shadow Erase	☆	←	
Erase Center	☆	←	
Repeat Separation Line	—	—	Not available with Connect Copy.
Double Copies Separation Line	—	—	Not available with Connect Copy.
Combine Separation Line	☆	←	The master unit setting will be applied.
Booklet/Magazine Original Orientation	—	—	Not available with Connect Copy.
Input/Output			
Individual Input/Output Operation	☆	—	Originals will be scanned before copying in Connect Copy mode.
Next Job Scan Start	☆	—	
Batch (SADF) Auto Reset Time	☆	—	
ARDF Original Table Rise Time	☆	—	
Face-Up/Down Selection in Platen Mode	—	—	This setting will be ignored and the setting programmed for Connect Copy will be used.  Reference See “step 1” in⇒ P.17 “Making Copies”

Menu	Master Unit	Sub-Unit	Remarks
Duplex: Auto Eject	☆	←	The master unit setting will be applied.
Combine: Auto Eject	☆	←	The master unit setting will be applied.
Rotate Sort Auto Paper Continue	☆	☆	This function is effective when "Auto Tray Switching" of the User Tools (System Settings) setting is "Yes".
Auto Sort Mode	☆	—	
Memory Full Auto Scan Restart	☆	←	The master unit setting will be applied.
Count Manager			
Check/Reset/Print Copy Counter	—	—	
User Code Register/Change/Delete	—	—	
Face-Up/Down selection in Bypass Mode	—	—	Can be used with the Cover/Designate functions only.













 **User Tools (Copy Features) For Connect Copy**

Count Manager

Menu	Description
Connect Copy	<p>Selects whether the [Connect] button is displayed or not. If you choose "No", the [Connect] key will not be displayed and this unit cannot become the master unit. As a default setting, "Yes" is selected. You can cancel this setting.</p> <p> Note</p> <p><input type="checkbox"/> Default : Yes</p>

5. APPENDIX

Specifications

	①	②	③
Continuous copying speed (full size)	110 copies/minute (A4  , 8 1/2" x 11"  size) 58 copies/minute (A3  , 11" x 17"  size)	130 copies/minute (A4  , 8 1/2" x 11"  size) 68 copies/minute (A3  , 11" x 17"  size)	120 copies/minute (A4  , 8 1/2" x 11"  size) 63 copies/minute (A3  , 11" x 17"  size)
Number of copies	1-999 sheets		

① With two 55 copies/minute models

② With two 65 copies/minute models

③ With one 55 copies/minute model and one 65 copies/minute model

INDEX

A

Adding Staples, 32
Adding Toner, 25, 32
Adjusting Copy Image Density, 21
Appendix, 43
Automatic Paper Select, 22
Auto Off, 20
Auto Reset, 20
Auto Start, 24

B

Basic Functions, 21
Bypass tray, 8

C

Clearing Misfeeds, 25, 31
Clear key, 11
Clear Modes/Energy Saver key, 10
Connect Copy, 1, 3
Connect Copy port, 8
Copying From The Bypass Tray, 22
Cover, 22
Cover/Designate, 22

D

Document feeder (ADF), 18
Document Server, 4

E

Energy Saver, 23

F

Finisher, i, 3

I

Indicators, 10
Interrupt, 4, 23
Interrupt key, 10

L

Large Capacity Tray (LCT), i
Loading Paper, 32

M

Main Power indicator, 10
Manual Paper Select, 22
Master Unit, 3

N

Number key, 11

O

Operation Panel, 10
Operation switch, 11
Options, i
Original Mode Quality Level, 4, 21
Originals, 18, 19
Original Type, 21

P

Panel Display, 12, 10
Paper Tray, 21
Printer, 4
Program, 22
Program key, 10

R

Removing Jammed Staples, 25, 31
Removing Punch Waste, 32

S

Sample Copy, 24
Sample Copy key, 10
Screen contrast knob, 10
Selecting Copy Paper, 21
Selecting Original Type Setting, 21
Start key, 11
Stop key, 11
Sub-Unit, 3

U

User Codes, 24
USER TOOLS, 35
User Tools/Counter key, 10